

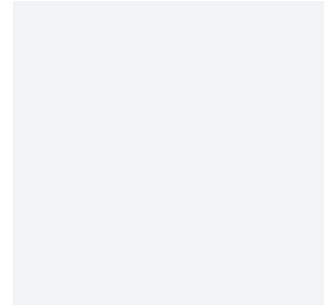

K-Cell Single Cut LED Strip

K-Cell 24V 5W IP20 White 2700K 50m
Code: K/24/01/20/01/27/S05/01

Category	LED Strip
Application	Hospitality, Residential, Retail
Specification	Architectural

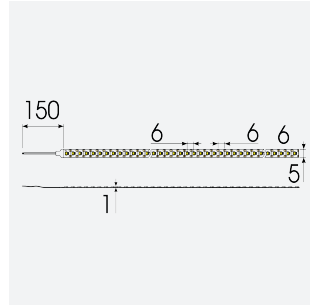
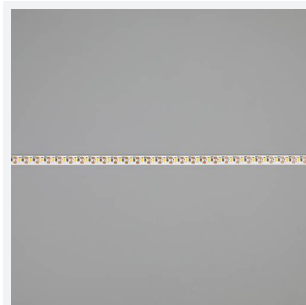

PRODUCT FEATURES

- K-CELL single cut LED strip suitable for high end residential, hospitality and retail applications
- High CRI ensures suitability for use within professional display and high end retail environments
- Joint and connection accessories sold separately
- Extremely small cutting points (every 5.66mm for 5W, every 8.33mm for 14.4W) ensures complete control over the exact run length of strip, for applications where accurate and precise light placement is paramount
- Fast fit plug and play connections remove the need for time consuming soldering of joints
- 168

GENERAL INFORMATION	
Wattage	5W/m
Lumens Delivered	380lm/m
Lm/W	76lm/W
Beam Angle	120
CRI	90
CCT	2700K
Input	24V
Operating Temp	-20°C - 45°C
SDCM	3
Product Weight without Packaging	0.4 kg

TECHNICAL INFORMATION	
Light Source	LED
IP Rating	IP20
Class Protection	3
Internal / External	Internal
Surface / Recessed / Suspended	Ceiling, Recessed, Wall
Lumen Depreciation	L70 50,000h
Warranty (Years)	5
CE Mark	Yes
Height	1.3 mm
LED Strip LEDs Per Metre	168

