

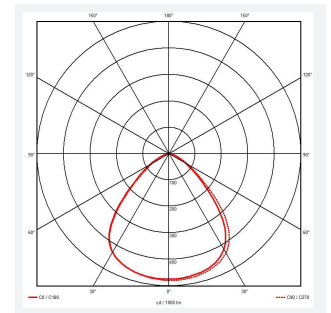

Z LED ECO

Z LED ECO Highbay 3 Cool White
Code: AZLE3/1/CW

Category	High/Low Bay
Application	Ancillary, Hospitality, Industrial, Retail
Specification	Performance

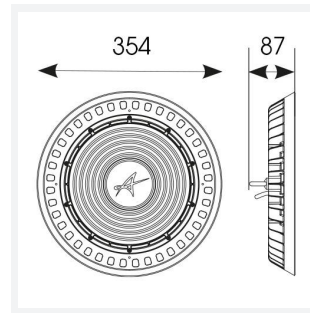

PRODUCT FEATURES

- Sleek and robust LED low/high bay for industrial applications and ancillary areas
- Lensed diffuser design helps to control the beam angle, offering better light distribution
- Integral on-board driver reduces the overall size and weight of product, resulting in a slim, lightweight and easy to install unit
- Alternative installation options by means of drop rods, jack chain and catenary wire.
- Die-cast powder coated construction and heatsink for optimum thermals and performance
- High efficiency up to 120lm/w
- Installation eye-bolt supplied as standard
- IP66 and IK09 ratings

GENERAL INFORMATION

Wattage	200W
Lumens Delivered	23500lm
Lm/W	120lm/W
Beam Angle	90
CRI	80
CCT	4000K
Input	220/240V
Operating Temp	-45°C - 45°C
SDCM	6
UGR	28
Energy efficiency class	E
Product Weight without Packaging	1.87 kg

TECHNICAL INFORMATION

Light Source	LED
Colour / Finish	Black
IP Rating	IP66
Class Protection	1
Internal / External	Internal / External
Surface / Recessed / Suspended	Suspended
Lumen Depreciation	L80 54,000h
Warranty (Years)	3
CE Mark	Yes
Diameter	354 mm
Height	87 mm

