

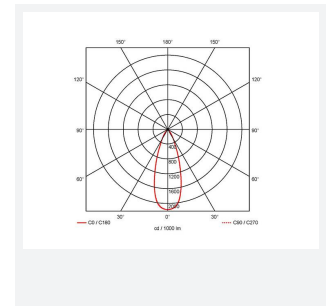

# Vantage UGR<19

|                      |   |
|----------------------|---|
| <b>Category</b>      | Downlights  |
| <b>Application</b>   | Ancillary, Commercial, Education, Healthcare, Hospitality, Retail |
| <b>Specification</b> | Performance   |

**Code:** AVANTLG2/WW/DD4/SM3

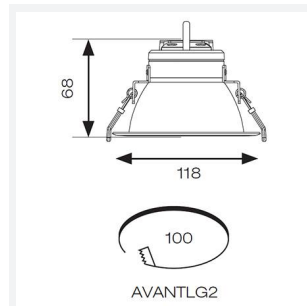
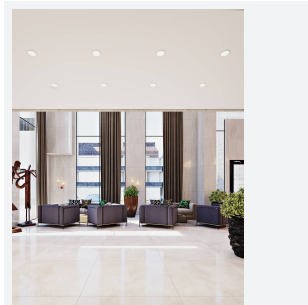
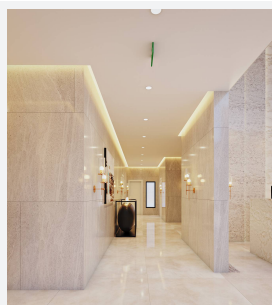

- UGR<19 performance downlight suitable for commercial and education applications
- UGR<19 (unified glare rating) compliant luminaire assisting to eliminate glare for visual comfort
- Anti-Ligature kit available for installation in secure environments such as healthcare and educational facilities
- Deep cut-off angle for glare control and comfort
- Downlight design allows installation into existing hole cut-outs from 68mm, 100mm, 150mm and 200mm
- Powered by Tridonic

## GENERAL INFORMATION

|                  |            |
|------------------|------------|
| Wattage          | 14W        |
| Lumens Delivered | 1400lm     |
| Lm/W             | 100lm/W    |
| Beam Angle       | 40         |
| CRI              | 90         |
| CCT              | 3000K      |
| Input            | 220-240V   |
| Operating Temp   | 0°C - 40°C |
| SDCM             | 6          |
| UGR              | 16         |
| Cut-Out Size     | 100mm      |

## TECHNICAL INFORMATION

|                                |             |
|--------------------------------|-------------|
| Light Source                   | LED         |
| Colour / Finish                | White       |
| IP Rating                      | IP20        |
| Class Protection               | 2           |
| Internal / External            | Internal    |
| Surface / Recessed / Suspended | Recessed    |
| Lumen Depreciation             | L80 72,000h |
| Warranty (Years)               | 5           |
| CE Mark                        | Yes         |
| Diameter                       | 118 mm      |
| Height                         | 68 mm       |

