

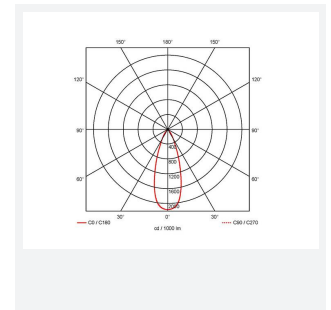

Vantage UGR<19

Vantage UGR<19 2 Cool White Downlight
Code: AVANTLG2/CW/M3

Category	Downlights
Application	Ancillary, Commercial, Education, Healthcare, Hospitality, Retail
Specification	Performance

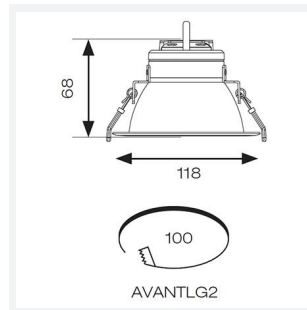

PRODUCT FEATURES

- UGR<19 performance downlight suitable for commercial and education applications
- UGR<19 (unified glare rating) compliant luminaire assisting to eliminate glare for visual comfort
- Anti-Ligature kit available for installation in secure environments such as healthcare and educational facilities
- Deep cut-off angle for glare control and comfort
- Downlight design allows installation into existing hole cut-outs from 68mm, 100mm, 150mm and 200mm
- Powered by Tridonic

GENERAL INFORMATION	
Wattage	14W
Lumens Delivered	1500lm
Lm/W	107lm/W
Beam Angle	40
CRI	90
CCT	4000K
Input	220/240V
Operating Temp	0°C - 40°C
SDCM	6
UGR	16
Cut-Out Size	100mm
Product Weight without Packaging	0.208 kg

TECHNICAL INFORMATION	
Light Source	LED
Colour / Finish	White
IP Rating	IP20
Class Protection	2
Internal / External	Internal
Surface / Recessed / Suspended	Recessed
Lumen Depreciation	L80 72,000h
Warranty (Years)	5
CE Mark	Yes
Diameter	118 mm
Height	68 mm

