

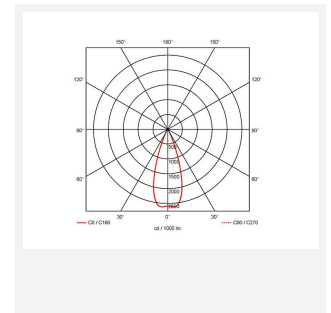

Vantage

Vantage CCT 3 Downlight Self-test Emergency Code: AVANTLED3/SM3

Category	Downlights
Application	Ancillary, Commercial, Education, Healthcare, Hospitality, Retail
Specification	Performance

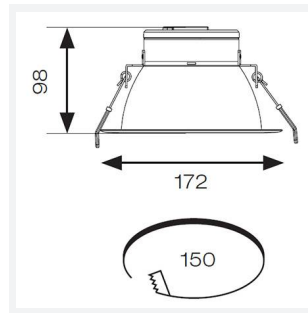

PRODUCT FEATURES

- CCT selectable LED performance downlight suitable for commercial and education applications
- One product provides 3000K, 4000K and 6500K colour temperature options
- Anti-Ligature kit available for installation in secure environments such as healthcare and educational facilities
- Deep cut-off angle for glare control and comfort
- Downlight design allows installation into existing hole cut-outs from 68mm, 100mm, 150mm and 200mm
- Powered by Tridonic

GENERAL INFORMATION	
Wattage	20W
Lumens Delivered	2100lm (4000K)
Lm/W	112lm/W (4000K)
Beam Angle	75
CRI	80
CCT	3000/4000/6500K
Input	220/240V
Operating Temp	0°C - 40°C
SDCM	6
UGR	25
Cut-Out Size	150mm
Product Weight without Packaging	0.288 kg

TECHNICAL INFORMATION	
Light Source	LED
Colour / Finish	White
IP Rating	IP20
Class Protection	2
Internal / External	Internal
Surface / Recessed / Suspended	Recessed
Lumen Depreciation	L80 100,000h
Warranty (Years)	5
CE Mark	Yes
Diameter	172 mm
Height	98 mm

