

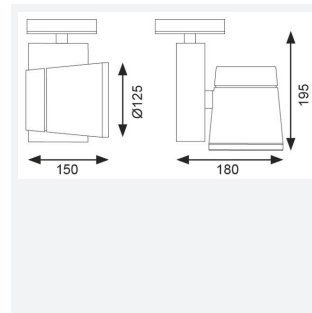

Single Circuit Unity 4 Mains

Single Circuit Unity 4 Warm White Mains White
Code: AULEDS4/WW/W

Category	Track Lighting
Application	Ancillary, Hospitality, Residential, Retail
Specification	Architectural



PRODUCT FEATURES

- Compact LED trackspot with integral driver suitable for residential, hospitality and retail applications
- Mirror finish anodized reflector
- Non-dimmable
- 355° rotation with 0-180° tilt on the bracket
- Anti-glare design to create visual comfort
- Powered by Tridonic

GENERAL INFORMATION	
Wattage	42W
Lumens Delivered	3700lm
Lm/W	88lm/W
Beam Angle	40
CRI	90
CCT	3000K
Input	220/240V
Operating Temp	-20°C - 25°C
SDCM	3
UGR	16
Product Weight without Packaging	1.301 kg

TECHNICAL INFORMATION	
Light Source	LED
Colour / Finish	White
IP Rating	IP20
Class Protection	1
Internal / External	Internal
Lumen Depreciation	L80 60,000h
Warranty (Years)	5
CE Mark	Yes
Diameter	125 mm
Height	206 mm
Accessories	AMON/GU10/W, AMON/GU10/B, AURA/110/20, AURA/110/60

