

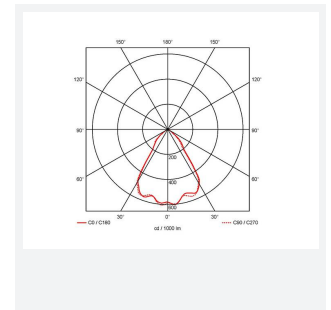

Unity 150

Unity 150 Downlight Cool White Switch Dim
Code: AULED150D/DD1

Category	Downlights
Application	Ancillary, Commercial, Education, Hospitality, Residential, Retail
Specification	Architectural

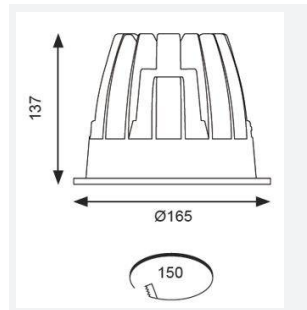
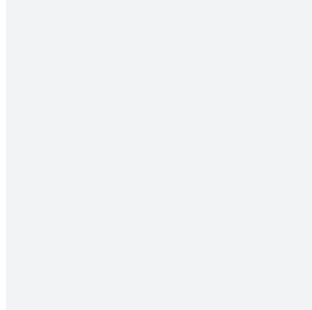

PRODUCT FEATURES

- IP44 compact high performance architectural downlight suitable for commercial, hospitality and retail applications
- Mirror finished anodized reflector
- Remote driver with plug and play connection
- Powered by Tridonic
- Die-cast aluminium construction, powder coated and 30° cut-off angle
- Anti-glare design to create visual comfort
- Dimmable and emergency options

GENERAL INFORMATION	
Wattage	37W
Lumens Delivered	3200lm
Lm/W	88lm/W
Beam Angle	70
CRI	90
CCT	4000K
Input	220-240V
Operating Temp	-20°C - 25°C
SDCM	3
UGR	22
Cut-Out Size	150mm
Product Weight without Packaging	1.2 kg

TECHNICAL INFORMATION	
Light Source	LED
Colour / Finish	White
IP Rating	IP44
Class Protection	2
Internal / External	Internal
Surface / Recessed / Suspended	Recessed
Lumen Depreciation	L70 50,000h
Warranty (Years)	5
CE Mark	Yes
Diameter	165 mm
Height	137 mm

