

Tornado PRO

Tornado PRO Twin 1500mm High Output 2
Code: ATORPLED2X5/HO/2/MWS/M3

Category	Battens and Weatherproofs
Application	Ancillary, Commercial, Education, Healthcare, Hospitality, Industrial, Retail
Specification	Performance

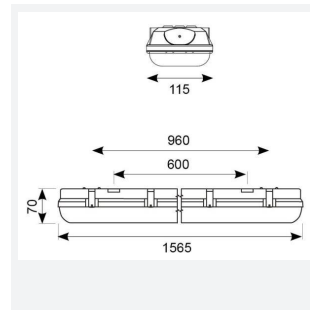

PRODUCT FEATURES

- Ultra slim IP65 LED robust non-corrosive batten ideal for industrial applications and ancillary areas
- Unique base design caters for multiple installation methods
- Quick release LED array / gear tray assembly provides the installer the means to faster installation / maintenance
- Self-test emergency option with Li-ion battery technology, reducing charge time and running costs
- High efficiency up to 161 Lm/W
- Installer friendly embedded features aid accurate and fast installation for any application
- Fast latching / permanently located stainless steel side clips ensure a quick and secure connection
- High output 5ft options available

GENERAL INFORMATION	
Wattage	115W
Lumens Delivered	18000lm
Lm/W	158lm/W
Beam Angle	100/120
CRI	80
CCT	4000K
Input	220/240V
Operating Temp	0°C - 40°C
SDCM	6
UGR	28
Product Weight without Packaging	2.106 kg

TECHNICAL INFORMATION	
Light Source	LED
Colour / Finish	Grey
IP Rating	IP65
Class Protection	1
Internal / External	Internal / External
Surface / Recessed / Suspended	Ceiling, Suspended
Lumen Depreciation	L80 54,000h
Warranty (Years)	7
CE Mark	Yes
Height	70 mm

