

Tornado EVO

Tornado EVO 1800mm OCTO Smart Control Self-Code: ATOREVO6/OCTO/SM3

Category	Battens and Weatherproofs
Application	Ancillary, Commercial, Education, Healthcare, Hospitality, Industrial, Retail
Specification	Performance

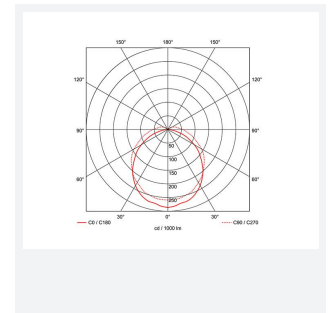
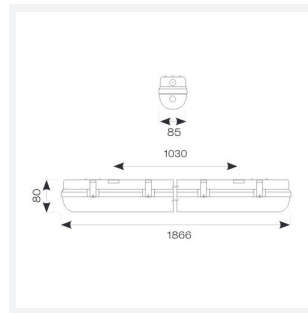

PRODUCT FEATURES

- IP65 non-corrosive batten suitable for industrial applications and ancillary areas
- Unique luminaire fixing clip design allows option of mounting onto BESA box
- Lockable heavy-duty stainless steel clips supplied as standard for added safety and security
- LED Performance allows point-to-point replacement of existing fluorescent luminaires
- High efficiency up to 140 Lm/W

GENERAL INFORMATION	
Wattage	35W
Lumens Delivered	5000lm
Lm/W	140lm/W
Beam Angle	105/125
CRI	80
CCT	4000K
Input	220/240V
Operating Temp	0°C - 40°C
SDCM	6
Product Weight without Packaging	2.349 kg

TECHNICAL INFORMATION	
Light Source	LED
Colour / Finish	Grey
IP Rating	IP65
Class Protection	1
Internal / External	Internal / External
Surface / Recessed / Suspended	Ceiling, Suspended
Lumen Depreciation	L80 54,000h
Warranty (Years)	5
CE Mark	Yes
Height	80 mm

