

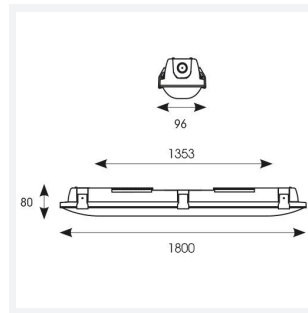

Tornado EVO

Tornado EVO CCT Multi Wattage 1800mm DALI
Code: ATORE6/1/DD3/DM3

| | |
|---------------|---|
| Category | Battens and Weatherproofs |
| Application | Ancillary, Commercial, Education, Healthcare, Hospitality, Industrial, Retail |
| Specification | Performance |



PRODUCT FEATURES

- IP65 non-corrosive batten suitable for industrial applications and ancillary areas
- CCT selectable between 4000K, 5000K and 6500K and power selectable; offering a choice of 2 outputs, in one luminaire
- LED performance allows point-to-point replacement of existing fluorescent luminaires
- Whole luminaire illuminates during emergency operation rather than a small area, allowing less emergency versions required on an installation
- High efficiency up to 160 Lm/W
- Slim sloped diffuser design creates sleek appearance and offers greater light distribution
- Lockable heavy-duty stainless steel clips supplied as standard for added safety and security

| GENERAL INFORMATION | |
|----------------------------------|-------------------------|
| Wattage | 35W/70W |
| Lumens Delivered | 5200lm - 9600lm (4000K) |
| Lm/W | 150lm/W (4000K) |
| Beam Angle | 120 |
| CRI | 80 |
| CCT | 4000/5000/6500K |
| Input | 220-240V |
| Operating Temp | 0°C - 40°C |
| SDCM | 3 |
| Energy efficiency class | D |
| Product Weight without Packaging | 2.7 kg |

| TECHNICAL INFORMATION | |
|--------------------------------|---------------------|
| Light Source | LED |
| Colour / Finish | Grey |
| IP Rating | IP65 |
| Class Protection | 1 |
| Internal / External | Internal / External |
| Surface / Recessed / Suspended | Ceiling, Suspended |
| Lumen Depreciation | L80 100,000h |
| Warranty (Years) | 5 |
| CE Mark | Yes |
| Height | 80 mm |

