

Tornado EVO

Tornado EVO CCT Multi Wattage 1500mm DALI
Code: ATORE5/1/DD3/SM3

Category	Battens and Weatherproofs
Application	Ancillary, Commercial, Education, Healthcare, Hospitality, Industrial, Retail
Specification	Performance

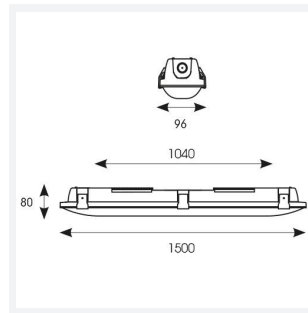

PRODUCT FEATURES

- IP65 non-corrosive batten suitable for industrial applications and ancillary areas
- CCT selectable between 4000K, 5000K and 6500K and power selectable; offering a choice of 2 outputs, in one luminaire
- LED performance allows point-to-point replacement of existing fluorescent luminaires
- Whole luminaire illuminates during emergency operation rather than a small area, allowing less emergency versions required on an installation
- High efficiency up to 160 Lm/W
- Slim sloped diffuser design creates sleek appearance and offers greater light distribution
- Lockable heavy-duty stainless steel clips supplied as standard for added safety and security

GENERAL INFORMATION	
Wattage	30W/60W
Lumens Delivered	4600lm - 8600lm (4000K)
Lm/W	150lm/W (4000K)
Beam Angle	120
CRI	80
CCT	4000/5000/6500K
Input	220-240V
Operating Temp	0°C - 40°C
SDCM	3
Energy efficiency class	D
Product Weight without Packaging	2.2 kg

TECHNICAL INFORMATION	
Light Source	LED
Colour / Finish	Grey
IP Rating	IP65
Class Protection	1
Internal / External	Internal / External
Surface / Recessed / Suspended	Ceiling, Suspended
Lumen Depreciation	L80 100,000h
Warranty (Years)	5
CE Mark	Yes
Height	80 mm

