

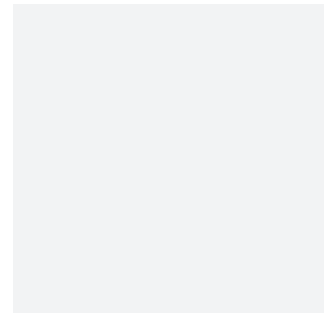

Proline Evo

Category	Commercial Linear
Application	Commercial, Education
Specification	Performance

Code: APRE4/1/CF/DM3

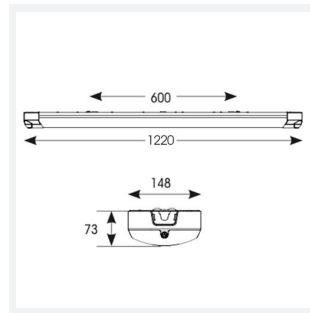

- Surface linear suitable for educational and commercial applications
- Steel powder coated body with reeded opal polycarbonate diffuser and retained end caps
- CCT selectable between 3000K and 4000K and power selectable; offering a choice of 2 outputs, in one luminaire
- Corridor Function for dimmable microwave sensor options
- Modern contemporary fully enclosed high performance surface luminaire
- Low glare and uniform light distribution
- Self-test emergency option
- Powered by Philips and Tridonic drivers

GENERAL INFORMATION

Wattage	21W - 36W
Lumens Delivered	2800lm - 4700lm (4000K)
Lm/W	130lm/W
Beam Angle	120
CRI	80
CCT	3000/4000K
Input	220-240V
Operating Temp	5°C - 40°C
SDCM	6
UGR	22

TECHNICAL INFORMATION

Light Source	LED
Colour / Finish	White
IP Rating	IP20
Class Protection	1
Internal / External	Internal
Surface / Recessed / Suspended	Ceiling, Suspended
Lumen Depreciation	L70 54,000h
Warranty (Years)	5
CE Mark	Yes
Height	73 mm

