

Pace UGR<19 600x600

Pace Backlit 600x600 Panel UGR<19 Warm White
Code: APAC1/60/1/WW/DD1

Category	Commercial Panels
Application	Ancillary, Commercial, Education, Healthcare, Industrial, Retail
Specification	Performance

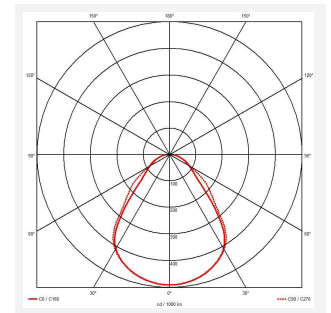
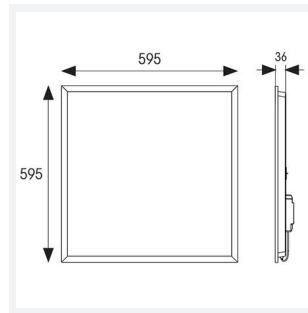
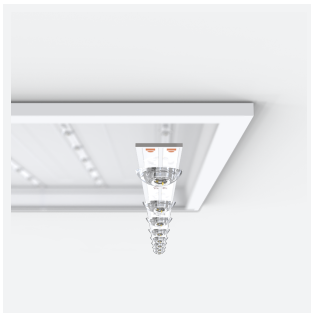

PRODUCT FEATURES

- Backlit LED panel suitable for education, commercial and ancillary area applications
- TPb as standard
- Slimline design allows for installation into shallow ceiling voids
- Self-Test Panel Pod and Sensor Pod compatible

GENERAL INFORMATION	
Wattage	28W
Lumens Delivered	3200lm
Lm/W	115lm/W
Beam Angle	90
CRI	80
CCT	3000K
Input	220-240V
Operating Temp	-20°C - 40°C
SDCM	3
UGR	18
Cut-Out Size	585x585mm
Product Weight without Packaging	2.023 kg

TECHNICAL INFORMATION	
Light Source	LED
Colour / Finish	White
IP Rating	IP40
Class Protection	2
Internal / External	Internal
Surface / Recessed / Suspended	Ceiling, Recessed, Suspended
Lumen Depreciation	L80 60,000h
Warranty (Years)	5
CE Mark	Yes
Height	32 mm

