

Otto EVO

Otto EVO CCT Suspended Linear Twin 1500mm
Code: AOTEVLED2X5/W/DD3/M3

Category	Commercial Linear
Application	Commercial, Education
Specification	Architectural

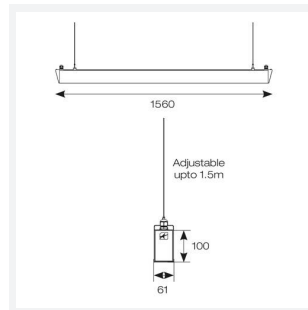
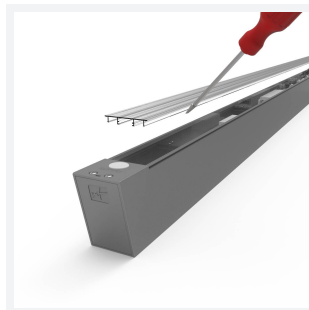

PRODUCT FEATURES

- Architectural suspended linear for office, retail and educational applications
- Adjustable bracket system allows complete flexibility for mounting installation
- Selectable CCT between 3000K and 4000K output
- Suitable for individual or continuous suspension
- Slim profile available in white and aluminium finishes
- Specially designed diffuser allows installer quick access to wiring ensuring a quick and easy installation
- Supplied bidirectional light output as standard (directional only option can be selected if required)
- Die-Cast aluminium end caps

GENERAL INFORMATION	
Wattage	58W - 66W
Lumens Delivered	7100lm - 8000lm (4000K)
Lm/W	122lm/W (4000K)
Beam Angle	110
CRI	80
CCT	3000/4000K
Input	220/240V
Operating Temp	0°C - 25°C
SDCM	3
UGR	25
Product Weight without Packaging	4.82 kg

TECHNICAL INFORMATION	
Light Source	LED
Colour / Finish	White
IP Rating	IP20
Class Protection	1
Internal / External	Internal
Surface / Recessed / Suspended	Suspended
Lumen Depreciation	L80 60,000h
Warranty (Years)	5
CE Mark	Yes
Height	100 mm
Accessories	AOTEVLED/90, AOTEVLED/90/W, AOTEVLED500, AOTEVLED1000, AOTEVLED1500

