

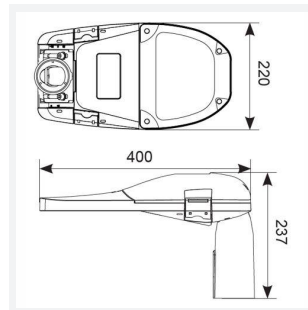

Onix

Onix Street Light 1
Code: AONIXLED/1

Category	Streetlights
Application	Commercial, Education, Healthcare, Outdoor
Specification	Performance



PRODUCT FEATURES

- Modern die-cast aluminium street light suitable for residential and commercial applications
- UV stabilized polycarbonate cover
- Built in anti-tamper isolation facility
- G3 Glare Rating
- Die-cast aluminium construction for optimal heat dissipation and performance
- Toolless gear tray removal for ease of maintenance
- Compatible with post top or side entry utility 76mm spigot
- Surge protection

GENERAL INFORMATION	
Wattage	14W
Lumens Delivered	2000lm
Lm/W	150lm/W
Beam Angle	120/70
CRI	70
CCT	5000K
Input	220-240V
Operating Temp	-20°C - 50°C
SDCM	5
Product Weight without Packaging	3.76 kg

TECHNICAL INFORMATION	
Light Source	LED
Colour / Finish	Graphite
IP Rating	IP66
Class Protection	1
Internal / External	External
Surface / Recessed / Suspended	Pole, Wall
Lumen Depreciation	L70 50,000h
Warranty (Years)	5
CE Mark	Yes
Height	237 mm
Accessories	AONIXLED/SBA, AONIXLED/WB

