



Opti-Linear

Category High/Low Bay

Application Industrial

Specification Performance

Code: AOLLBLED/3/MWS/M3

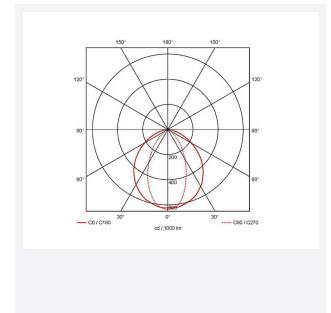
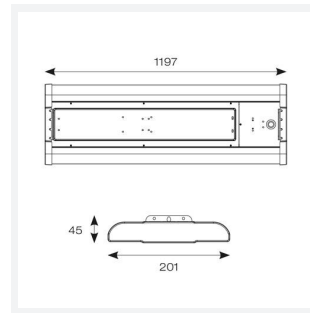
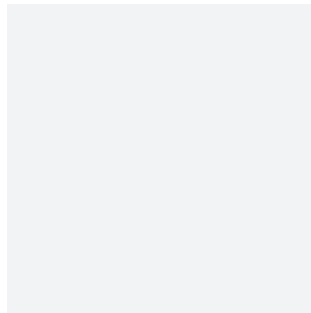

- LED low bay suitable for industrial and commercial applications
- Fast install/wiring via access hatch on the back of the product with push fit terminals
- Supplied c/w 1.5 metre catenary suspension kit
- 1-10V dimmable as standard

- Ideal for any retro-fit applications replacing any traditional light sources
- Instant light output and unlimited switching
- Mild Steel powder coat construction

GENERAL INFORMATION

Wattage	202W
Lumens Delivered	26000lm
Lm/W	131lm/W
Beam Angle	50/100
CRI	80
CCT	4000K
Input	220-240V
Operating Temp	0°C - 45°C
SDCM	5
Product Weight without Packaging	2.82 kg

TECHNICAL INFORMATION

Light Source	LED
Colour / Finish	White
IP Rating	IP20
Class Protection	1
Internal / External	Internal
Surface / Recessed / Suspended	Suspended
Lumen Depreciation	L80 54,000h
Warranty (Years)	3
CE Mark	Yes
Height	45 mm

