

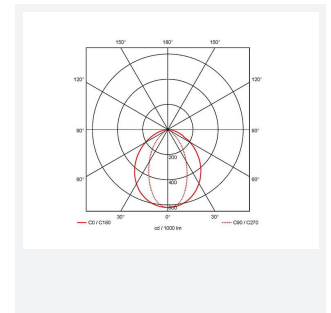

Opti-Linear

Opti-Linear Low Bay 1
Code: AOLLBLED/1

Category	High/Low Bay
Application	Industrial
Specification	Performance

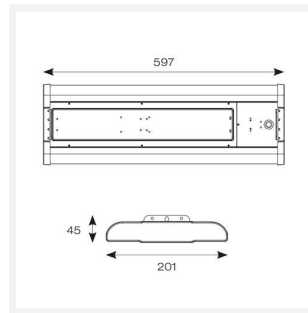

PRODUCT FEATURES

- LED low bay suitable for industrial and commercial applications
- Fast install/wiring via access hatch on the back of the product with push fit terminals
- Supplied c/w 1.5 metre catenary suspension kit
- 1-10V dimmable as standard
- Ideal for any retro-fit applications replacing any traditional light sources
- Instant light output and unlimited switching
- Mild Steel powder coat construction

GENERAL INFORMATION	
Wattage	77W
Lumens Delivered	11000lm
Lm/W	144lm/W
Beam Angle	50/100
CRI	80
CCT	4000K
Input	220/240V
Operating Temp	-30°C - 45°C
SDCM	5
Product Weight without Packaging	1.898 kg

TECHNICAL INFORMATION	
Light Source	LED
Colour / Finish	White
IP Rating	IP20
Class Protection	1
Internal / External	Internal
Surface / Recessed / Suspended	Suspended
Lumen Depreciation	L80 54,000h
Warranty (Years)	3
CE Mark	Yes
Height	45 mm

