

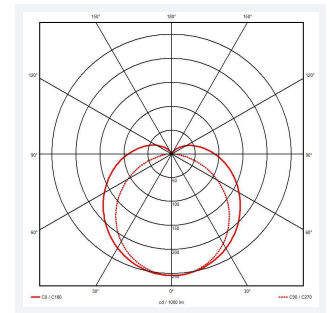

NouLine

NouLine Batten 1800mm CCT Self-Test Emergency Code: ANOU6/2/SM3

Category	Battens and Weatherproofs
Application	Ancillary, Commercial, Industrial
Specification	Performance

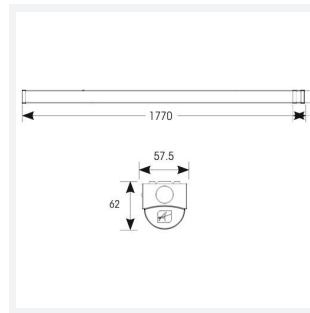

PRODUCT FEATURES

- High performance LED batten suitable for industrial applications and ancillary areas
- Excellent light uniformity through high transmittance polycarbonate diffuser
- Push fit terminals for ease and speed of installation
- Non-dimmable
- High efficiency up to 140lm/W
- Instant light output with unlimited switching
- Multiple conduit entry and BESA fixing points

GENERAL INFORMATION	
Wattage	50W/35W
Lumens Delivered	4900lm - 6900lm (4000K)
Lm/W	140lm/W
Beam Angle	110/150
CRI	80
CCT	3000K/4000K/6500K
Input	220/240V
Operating Temp	0°C to 30°C
SDCM	6
Product Weight without Packaging	1.401 kg

TECHNICAL INFORMATION	
Light Source	LED
Colour / Finish	White
IP Rating	IP20
Class Protection	1
Internal / External	Internal
Surface / Recessed / Suspended	Ceiling, Suspended
Lumen Depreciation	L70 54,000h
Warranty (Years)	5
CE Mark	Yes

