

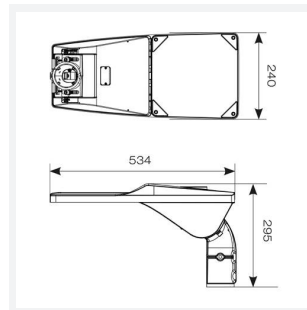

# Magna

Magna Street Light Photocell 2 Cool White  
Code: AMAGLED/2/PC

Category	Streetlights
Application	Commercial, Education, Healthcare, Outdoor
Specification	Performance



- Modern die-cast aluminium street light suitable for residential and commercial applications
- UV stabilized polycarbonate cover
- Built in anti-tamper isolation facility
- Advanced lens technology providing optimum performance and control.
- Die-cast aluminium construction for optimal heat dissipation and performance
- Toolless gear tray removal for ease of maintenance
- Compatible with post top or side entry utility 76mm spigot
- G3 Glare Rating

GENERAL INFORMATION	
Wattage	50W
Lumens Delivered	7800lm
Lm/W	152lm/W
Beam Angle	50x140
CRI	70
CCT	4000K
Input	220-240V
Operating Temp	-30°C - 50°C
SDCM	3
Product Weight without Packaging	5.66 kg

TECHNICAL INFORMATION	
Light Source	LED
Colour / Finish	Black
IP Rating	IP66
Class Protection	1
Internal / External	External
Surface / Recessed / Suspended	Pole
Lumen Depreciation	L80 100,000h
Warranty (Years)	5
CE Mark	Yes
Height	295 mm
Accessories	AMAGLED/SBA

