

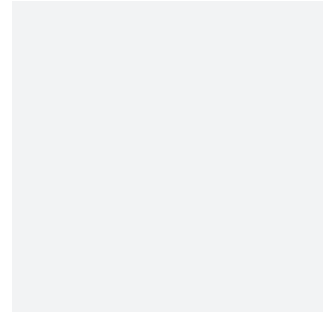

Kamar

Kamar Floodlight 3 4000K 30° Symmetrical DALI
Code: AKAR3/1/40/WB/DD3

Category	Floodlights
Application	Commercial, Hospitality, Industrial, Outdoor, Retail
Specification	Architectural

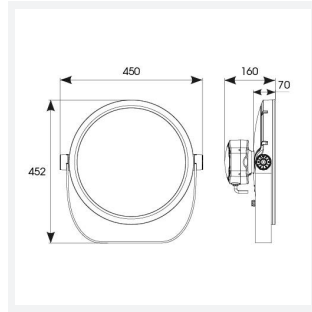

PRODUCT FEATURES

- High performance projector with a vast number of customisation options suitable for all commercial, hospitality, retail and industrial applications
- Beam angle options ranging from 8° up to 60° ensure suitability for most applications
- Low glare hood and honeycomb film accessories available for projects when glare optimisation and upward lighting are considerations
- Die-cast construction provides sleek and modern appearance, perfect for architectural applications
- Multiple control options available, DALI (as standard), DMX and Casambi (35W and 100W only) as well as an extensive collection of CCT options (2000K, 2200K, 2700K, 3000K, 4000K, 5000K, TW, RGBW) provide complete control and light output for even the most complex of projects

GENERAL INFORMATION

Wattage	100W
Lumens Delivered	8600lm
Lm/W	86lm/W
Beam Angle	30°
CRI	80
CCT	4000K
Input	220-240V
Operating Temp	-30°C - 50°C
SDCM	6
Product Weight without Packaging	10 kg

TECHNICAL INFORMATION

Light Source	LED
Colour / Finish	Silver
IP Rating	IP66
Class Protection	1
Internal / External	Internal / External
Surface / Recessed / Suspended	Floor, Pole, Wall
Lumen Depreciation	L70 54,000h
Warranty (Years)	5
CE Mark	Yes
Diameter	394 mm
Height	452 mm

