

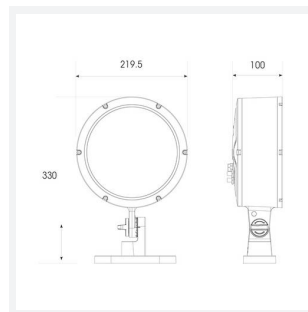

Kamar

Category	Floodlights
Application	Commercial, Hospitality, Industrial, Outdoor, Retail
Specification	Performance

Kamar Floodlight 1 RGBW 3000K 8° Symmetrical
Code: AKAR1/1/RGBW30/NB/OCTO

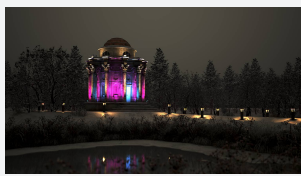

PRODUCT FEATURES

- High performance projector with a vast number of customisation options suitable for all commercial, hospitality, retail and industrial applications
- Beam angle options ranging from 8° up to 60° ensure suitability for most applications
- Low glare hood and honeycomb film accessories available for projects when glare optimisation and upward lighting are considerations
- Die-cast construction provides sleek and modern appearance, perfect for architectural applications
- Multiple control options available, DALI (as standard), DMX and Casambi (35W and 100W only) as well as an extensive collection of CCT options (2000K, 2200K, 2700K, 3000K, 4000K, 5000K, TW, RGBW) provide complete control and light output for even the most complex of projects

GENERAL INFORMATION

Wattage	35W
Beam Angle	8°
CRI	80
CCT	RGBW (RGB+3000K)
Input	220/240V
Operating Temp	-30°C - 50°C
SDCM	6
Product Weight without Packaging	3.7 kg

TECHNICAL INFORMATION

Light Source	LED
Colour / Finish	Silver
IP Rating	IP66
Class Protection	1
Internal / External	Internal / External
Surface / Recessed / Suspended	Floor, Wall
Lumen Depreciation	L70 54,000h
Warranty (Years)	5
CE Mark	Yes
Diameter	219.5 mm
Height	330 mm

