

# Kamar

|               |  |
|---------------|--|
| Category      | Floodlights  |
| Application   | Commercial, Hospitality, Industrial, Outdoor, Retail |
| Specification | Performance  |

Kamar Floodlight 1 RGBW 3000K 20° x 60°  
Code: AKAR1/1/RGBW30/ASY/OCTO

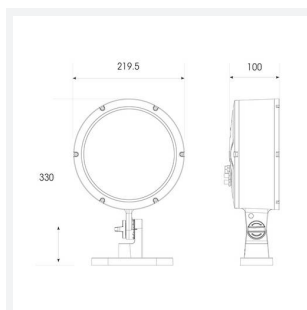
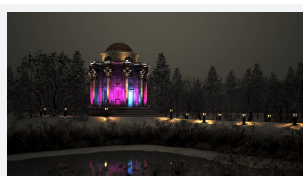

## PRODUCT FEATURES

- High performance projector with a vast number of customisation options suitable for all commercial, hospitality, retail and industrial applications
- Beam angle options ranging from 8° up to 60° ensure suitability for most applications
- Low glare hood and honeycomb film accessories available for projects when glare optimisation and upward lighting are considerations
- Die-cast construction provides sleek and modern appearance, perfect for architectural applications
- Multiple control options available, DALI (as standard), DMX and Casambi (35W and 100W only) as well as an extensive collection of CCT options (2000K, 2200K, 2700K, 3000K, 4000K, 5000K, TW, RGBW) provide complete control and light output for even the most complex of projects

### GENERAL INFORMATION

|                                  |                  |
|----------------------------------|------------------|
| Wattage                          | 35W              |
| Beam Angle                       | 20/60°           |
| CRI                              | 80               |
| CCT                              | RGBW (RGB+3000K) |
| Input                            | 220/240V         |
| Operating Temp                   | -30°C - 50°C     |
| SDCM                             | 6                |
| Product Weight without Packaging | 3.7 kg           |

### TECHNICAL INFORMATION

|                                |                     |
|--------------------------------|---------------------|
| Light Source                   | LED                 |
| Colour / Finish                | Silver              |
| IP Rating                      | IP66                |
| Class Protection               | 1                   |
| Internal / External            | Internal / External |
| Surface / Recessed / Suspended | Floor, Wall         |
| Lumen Depreciation             | L70 54,000h         |
| Warranty (Years)               | 5                   |
| CE Mark                        | Yes                 |
| Diameter                       | 219.5 mm            |
| Height                         | 330 mm              |

