

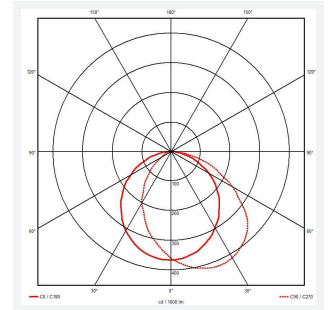

Hope Asymmetric

Category	Commercial Linear
Application	Ancillary, Commercial, Healthcare
Specification	Architectural

Code: AHOPL4/1/DD3/SM3

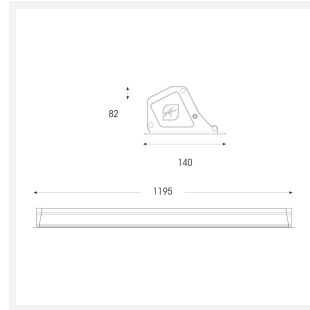

- Asymmetrical recessed linear suitable for healthcare applications
- Specially designed angled polycarbonate diffuser provides asymmetric light output, directing the light down and outwards, allowing installation into the perimeter or corridor and circulation areas, perfect for healthcare applications
- High efficiency up to 120lm/w
- CCT selectable between 3000K, 4000K and 5000K and power selectable; offering a choice of 2 outputs, in one luminaire
- Integral fixing clips allow for installation into plasterboard ceilings
- Dimmable Option available through ADDIM/50/MC

GENERAL INFORMATION	
Wattage	18W-28W
Lumens Delivered	2200lm - 3300lm (4000K)
Lm/W	120lm/W (4000K)
Beam Angle	75/110
CRI	80
CCT	3000/4000/5000K
Input	220-240V
Operating Temp	0°C - 50°C
SDCM	5
UGR	24

TECHNICAL INFORMATION	
Light Source	LED
Colour / Finish	White
IP Rating	IP40
Class Protection	2
Internal / External	Internal
Surface / Recessed / Suspended	Recessed
Lumen Depreciation	L80 54,000h
Warranty (Years)	5
CE Mark	Yes

