

Gemini

Gemini CCT Surface/Suspended Linear 1200mm
Code: AGELED4/DD4/DM3

Category	Commercial Linear
Application	Ancillary, Retail
Specification	Performance

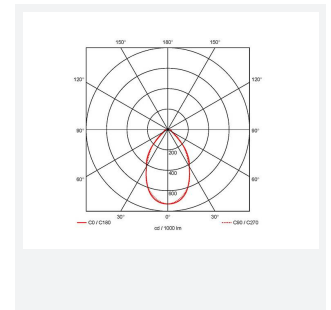
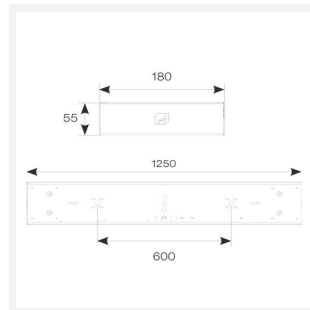
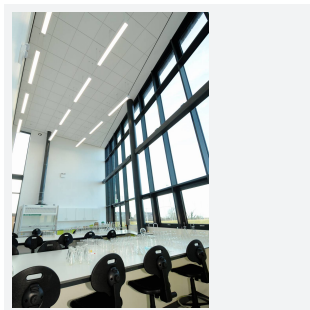
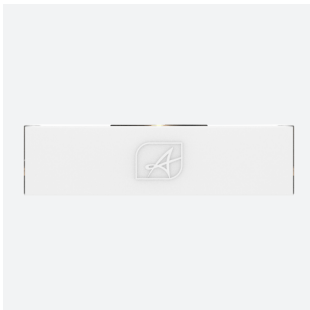

PRODUCT FEATURES

- High specification fully enclosed linear luminaire suitable for most commercial and educational applications
- Microprism diffuser for enhanced photometric performance
- CCT selectable between 3000K and 4000K and power selectable; offering a choice of 2 outputs, in one luminaire
- Powered by Philips
- Push pin release design feature ensures a quick and easy installation
- Robust steel construction
- Suitable for surface and suspension

GENERAL INFORMATION	
Wattage	21W - 35W
Lumens Delivered	2900lm - 4700lm (4000K)
Lm/W	135lm/W (4000K)
Beam Angle	70
CRI	80
CCT	3000/4000K
Input	220/240V
Operating Temp	0°C - 50°C
SDCM	3
UGR	18

TECHNICAL INFORMATION	
Light Source	LED
Colour / Finish	White
IP Rating	IP20
Class Protection	1
Internal / External	Internal
Surface / Recessed / Suspended	Ceiling, Suspended
Lumen Depreciation	L70 54,000h
Warranty (Years)	5
CE Mark	Yes
Height	55 mm

