

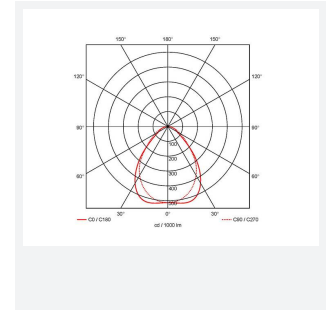

Endurance UGR<19 600x600

Endurance TP(a) UGR<19 600x600 Panel High
Code: AERMLED3/HO/60/CW/DD3

Category	Commercial Panels
Application	Ancillary, Commercial, Education, Healthcare, Retail
Specification	Performance

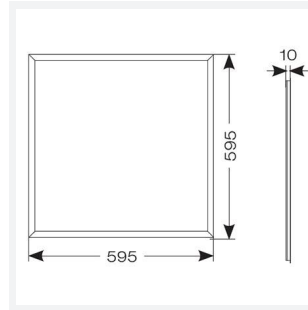
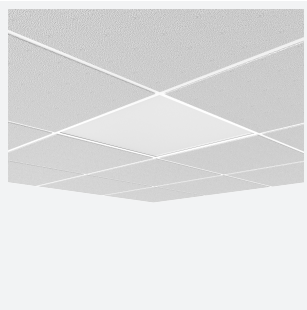

PRODUCT FEATURES

- Edge lit LED panel suitable for education, commercial and ancillary area applications
- Cool white, warm white and daylight options
- Low glare and even light distribution for multiple applications
- Surface mounting frame option
- UGR<19 (unified glare rating) compliant luminaire assisting to eliminate glare for visual comfort
- White anodised aluminium frame for visual compatibility with ceiling grid
- TPa as standard
- Powered by Tridonic

GENERAL INFORMATION	
Wattage	30W
Lumens Delivered	4300lm
Lm/W	139lm/W
Beam Angle	80
CRI	80
CCT	4000K
Input	220/240V
Operating Temp	-20°C - 40°C
SDCM	4
UGR	18
Cut-Out Size	585x585mm
Product Weight without Packaging	2.734 kg

TECHNICAL INFORMATION	
Light Source	LED
Colour / Finish	White
IP Rating	IP44
Class Protection	2
Internal / External	Internal
Surface / Recessed / Suspended	Ceiling, Recessed, Suspended
Lumen Depreciation	L80 76,000h
Warranty (Years)	5
CE Mark	Yes
Accessories	AERMLED/SK, AERMLED/60/SMF, AERMLED/60/CGCB/KIT, APRK/60

