

Cyclone

Cyclone Non-Corrosive 1200mm Warm White
Code: ACYCLED4/WW

Category	Battens and Weatherproofs
Application	Industrial
Specification	Performance

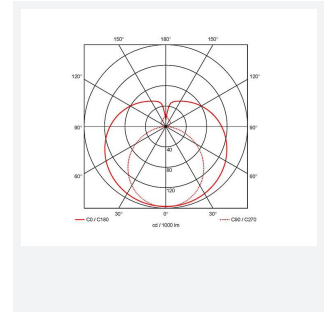
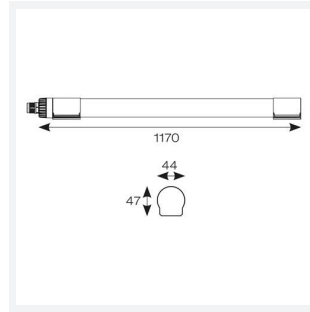

PRODUCT FEATURES

- Slim and lightweight economic polycarbonate LED non-corrosive suitable for industrial applications
- Quick and easy electrical connection without opening the luminaire
- Non-dimmable
- LED Performance allows point-to-point replacement of existing fluorescent luminaires
- IK08 impact rating offers superior product durability

GENERAL INFORMATION	
Wattage	25W
Lumens Delivered	3000lm
Lm/W	120lm/W
Beam Angle	360
CRI	80
CCT	3000K
Input	220/240V
Operating Temp	-20°C - 40°C
SDCM	6
Product Weight without Packaging	0.338 kg

TECHNICAL INFORMATION	
Light Source	LED
Colour / Finish	White
IP Rating	IP65
Class Protection	2
Internal / External	Internal / External
Surface / Recessed / Suspended	Ceiling
Lumen Depreciation	L80 54,000h
Warranty (Years)	2
CE Mark	Yes
Height	47 mm

