

Crescent

Category	Commercial Linear
Application	Ancillary, Commercial, Education
Specification	Performance

Code: ACRESLED5/DD1/SM3

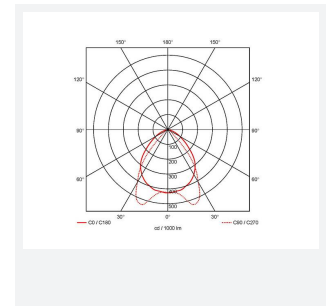
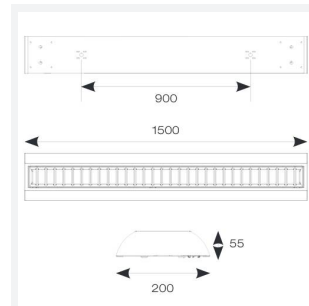

- High specification fully enclosed linear luminaire suitable for most commercial and educational applications
- Polycarbonate diffuser and polished louvre for excellent photometric performance
- Suitable for surface mounting and suspension

- Steel powder coated body for enhanced durability
- CCT selectable between 3000K and 4000K and power selectable; offering a choice of 2 outputs, in one luminaire
- Powered by Philips

GENERAL INFORMATION

Wattage	23W - 40W
Lumens Delivered	3000lm - 5600lm (4000K)
Lm/W	133-139lm/W (4000K)
Beam Angle	80
CRI	80
CCT	3000/4000K
Input	220-240V
Operating Temp	0°C - 50°C
SDCM	3
UGR	19

TECHNICAL INFORMATION

Light Source	LED
Colour / Finish	White
IP Rating	IP20
Class Protection	1
Internal / External	Internal
Surface / Recessed / Suspended	Ceiling, Suspended
Lumen Depreciation	L80 100,000h
Warranty (Years)	5
CE Mark	Yes

