

# Crescent

Crescent CCT Surface/Suspended Linear  
Code: ACRESLED4/DD1

Category	Commercial Linear
Application	Ancillary, Commercial, Education
Specification	Performance

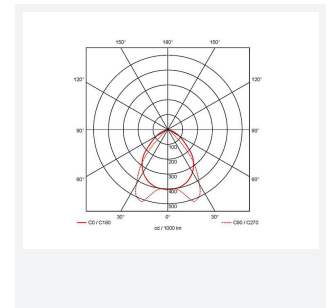
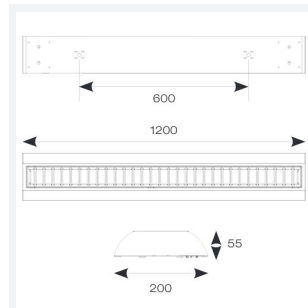

## PRODUCT FEATURES

- High specification fully enclosed linear luminaire suitable for most commercial and educational applications
- Polycarbonate diffuser and polished louvre for excellent photometric performance
- Suitable for surface mounting and suspension
- Steel powder coated body for enhanced durability
- CCT selectable between 3000K and 4000K and power selectable; offering a choice of 2 outputs, in one luminaire
- Powered by Philips

GENERAL INFORMATION	
Wattage	21W - 35W
Lumens Delivered	3100lm - 4900lm (4000K)
Lm/W	146-139lm/W (4000K)
Beam Angle	80
CRI	80
CCT	3000/4000K
Input	220-240V
Operating Temp	-20°C - 50°C
SDCM	3
UGR	18
Product Weight without Packaging	2.65 kg

TECHNICAL INFORMATION	
Light Source	LED
Colour / Finish	White
IP Rating	IP20
Class Protection	1
Internal / External	Internal
Surface / Recessed / Suspended	Ceiling, Suspended
Lumen Depreciation	L80 100,000h
Warranty (Years)	5
CE Mark	Yes

