

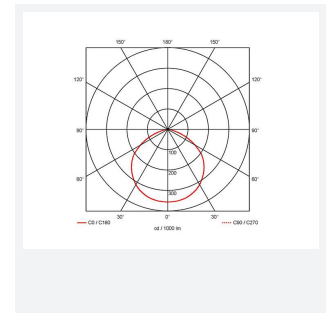

Aztec Coastal Symmetrical

Aztec Coastal Symmetrical Floodlight 300W
Code: AAZCLED300

Category	Floodlights
Application	Ancillary, Commercial, Education, Healthcare, Hospitality, Industrial, Outdoor, Retail
Specification	Performance

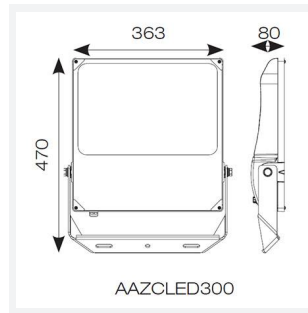

PRODUCT FEATURES

- High performance die-cast marine grade aluminium LED floodlight suitable for industrial and coastal applications
- Suitable for highly corrosive environments; including coastal and swimming pool applications
- Pre-wired with 1.5 metre of rubber insulated cable for ease of installation
- High purity aluminium construction, surface electrophoresis and corrosion-proof treatment
- 304L stainless steel mounting bracket and fixings
- Pre-installed breathable gland prevents internal moisture accumulation
- Concentrated saline 3,000 hour salt spray test to EN ISO 9227
- Salt mist spray test verified

GENERAL INFORMATION	
Wattage	300W
Lumens Delivered	44000lm
Lm/W	147lm/W
Beam Angle	115
CRI	70
CCT	5000K
Input	220-240V
Operating Temp	-30°C - 50°C
SDCM	5
Product Weight without Packaging	7.87 kg

TECHNICAL INFORMATION	
Light Source	LED
Colour / Finish	Aluminium
IP Rating	IP66
Class Protection	1
Internal / External	External
Surface / Recessed / Suspended	Pole, Wall
Lumen Depreciation	L80 54,000h
Warranty (Years)	5
CE Mark	Yes
Height	470 mm

