

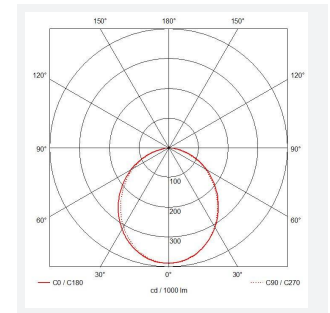

ARX Linear

ARX Anti-Ligature Surface Linear CCT 1500mm
Code: AARXL5/1/B/DD3

Category	Commercial Linear
Application	Commercial, Healthcare, Hospitality, Industrial
Specification	Performance

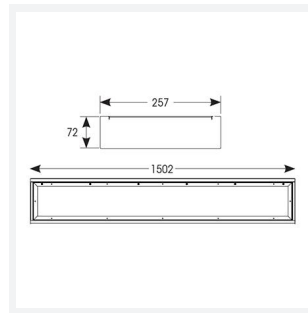

PRODUCT FEATURES

- Ultra robust anti-ligature surface linear fitting suitable for healthcare, education and external subway/walkway applications
- Intelligently designed 2 part construction means fewer screws when removing and re-attaching front frame, ensuring a quick and easy installation
- IK10 and IP54 ratings ensure anti-vandal resistance and suitability for anti-ligature applications
- CCT selectable between 4000K, 5000K and 6000K and power selectable; offering a choice of 6 outputs in one luminaire

GENERAL INFORMATION	
Wattage	14/28/43/57W
Lumens Delivered	1800-7300lm (4000K)
Lm/W	130lm/W (4000K)
Beam Angle	100
CRI	80
CCT	4000/5000/6500K
Input	220-240V
Operating Temp	-20°C - 40°C
SDCM	4
Product Weight without Packaging	12.5 kg

TECHNICAL INFORMATION	
Light Source	LED
Colour / Finish	Black
IP Rating	IP65
Class Protection	1
Internal / External	Internal / External
Surface / Recessed / Suspended	Ceiling
Lumen Depreciation	L80 90,000h
Warranty (Years)	5
CE Mark	Yes
Height	82 mm

