

HISTON STREET LIGHT 3000K/4000K 50W

NET-33-20-51

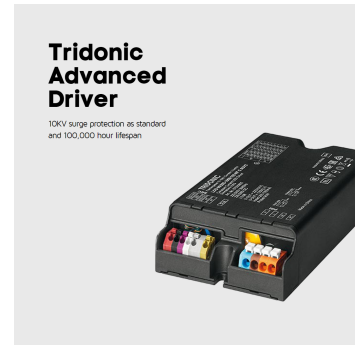

Features & Benefits

- Choose between two different colour temperatures (3000K or 4000K) at the time of installation
- Built-in, energy saving Virtual Midnight function - dim at the mid-point of sunset to sunrise to save additional energy
- Tridonic driver with 10KV surge protection and 100,000 hour lifespan
- Specialist lens for improved uniformity and larger light distribution
- Slip fitter included for use on 60 or 70mm pole
- Choose between two different mounting options (horizontal or vertical) with the adjustable spigot

Key Data

Power	50W
Luminous Flux	7350lm
Colour Temperature	3000K/4000K
IP Rating	IP66
IK Rating	IK08
Dimensions	Ø670 x 232 x 137mm
Warranty	5 Years (Registration Required)

Compatible Accessories

NET-23-20-08	3 Pin NEMA Photocell Sensor for Histon Street Lights
NET-23-16-51	Double Outreach Arm Bracket
NET-23-16-53	Flat Wall Bracket

NET LED Lighting

Buckingham Business Park, 300 Anderson Road,
Swavesey, Cambridge, CB24 4UQ

T: 01223 851505 | sales@netled.co.uk | www.netled.co.uk



ORDER BY 6PM
FOR NEXT DAY DELIVERY

Technical Specifications

Input Voltage (AC)	220-240V
Power Factor	0.98
Luminaire Efficacy	147lm/W
LED Manufacturer	Luxeon
LED Type	EMC 5050
No. of LEDs	60
Driver Manufacturer	Tridonic
Driver Output Voltage (DC)	80V (LV)
Total Circuit Power (W)	50W
Electrical Class	1
Colour Rendering	>70 CRI
Lamp Viewing Angle	140° x 70°
Dimmable	Virtual Midnight
Operating Temp.	-15°C to +40°C
Lifespan LM80	50,000 Hours
Weight	4.1Kg
Manufacturer	NET LED Lighting
Photocell Compatible	Yes - 3 Pin NEMA
Housing Colour	Grey
Housing Material	Aluminium Alloy
Diffuser Material	Glass
Dimming Input Type	NFC Programmed
Column Entry	60mm/76mm

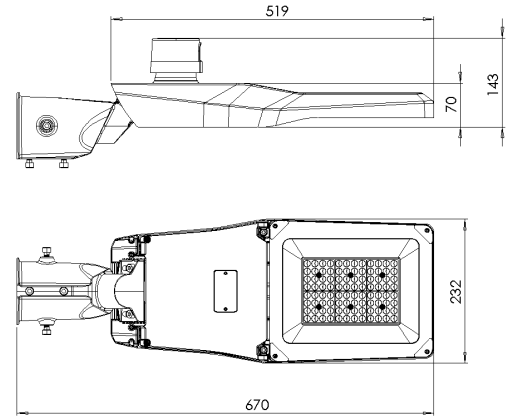

Other Options

Description	
NET-33-20-50	Histon Street Light 3000K/4000K 30W
NET-33-20-51	Histon Street Light 3000K/4000K 50W
NET-33-20-52	Histon Street Light 3000K/4000K 80W
NET-33-20-53	Histon Street Light 3000K/4000K 100W
NET-33-20-54	Histon Street Light 3000K/4000K 120W

NET LED Lighting

Buckingham Business Park, 300 Anderson Road,
Swavesey, Cambridge, CB24 4UQ



ORDER BY 6PM
FOR NEXT DAY DELIVERY

3K

4K

SELECTABLE COLOUR TEMPERATURE

Choose your colour temperature 3000K or 4000K

OPTIONAL 3 PIN NEMA PHOTOCELL SENSOR

Reduce energy costs and ensure the fitting comes on only when required

SPECIALIST LENS

Create a Batwing Beam Angle for improved uniformity and larger light distribution

ADJUSTABLE SPIGOT

Adjust the head in 5° increments from -15° to +15°

TRIDONIC DRIVER WITH 10KV SURGE PROTECTION AND BUILT-IN OPTIONAL VIRTUAL MIDNIGHT FUNCTION

Dim the fitting at the mid-point of sunset to sunrise to save additional energy