

**STRIKE PLATE KIT /
T SHAPED / 75MM
DOOR**

ACTION: STRIKE PLATES

RANGE: STRIKE PLATES

A solid metal strike plate designed to complement Buster + Punch door hardware and latch accessories, for a consistent feel everytime you open the door. Works great on all internal doors



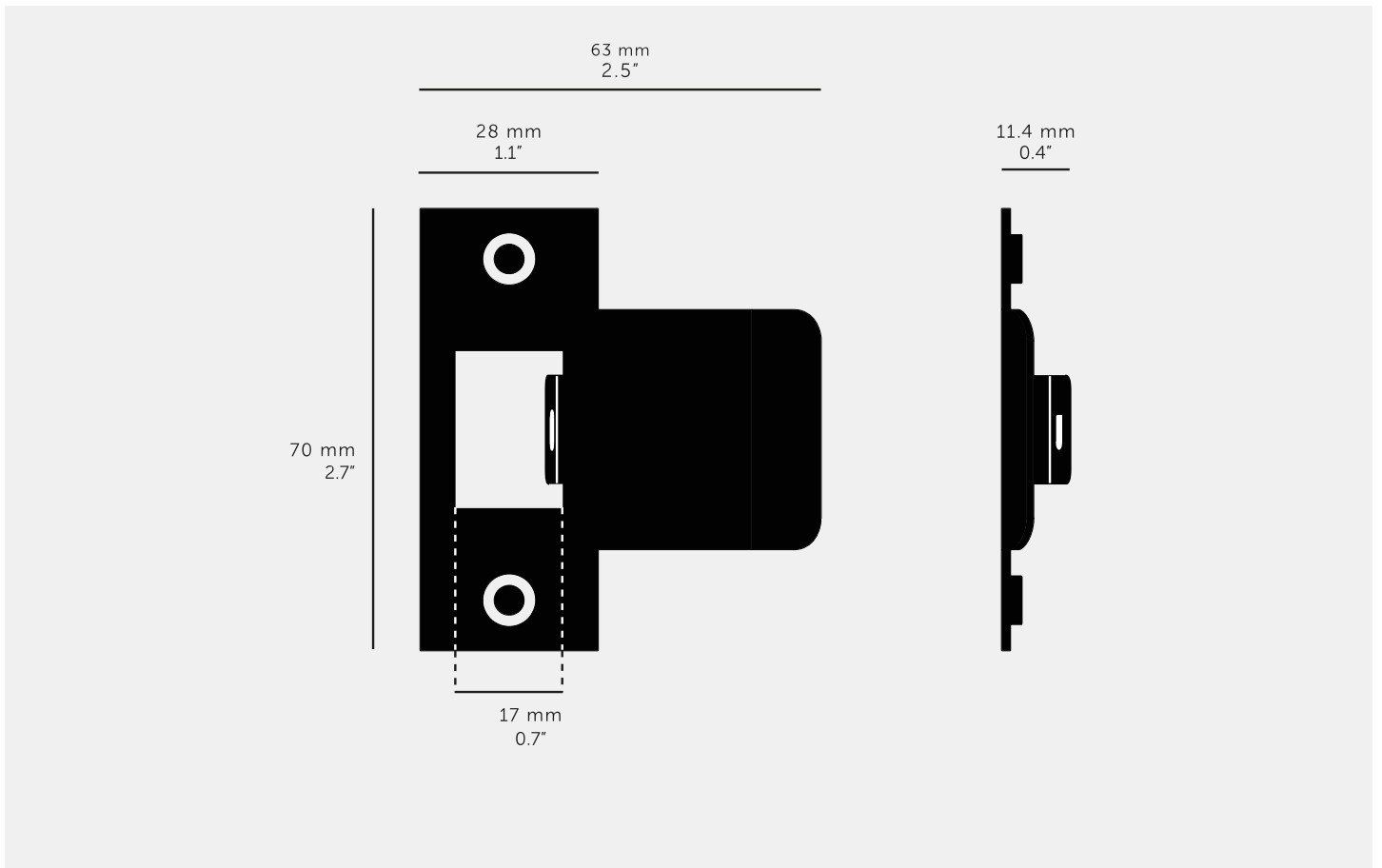

SPECIFICATIONS

A strike plate made from solid metal, with counter sunk screw holes. Designed to complement Buster + Punch door hardware and latch accessories. Fits 3" doors.

INCLUDED

1 x 3" Strike Plate
 2 x M4 x 62mm through bolts
 4 x Woodscrews in matching finish

PLEASE NOTE

DISCLAIMER: Always consult a trade professional when installing these strike plates. Buster + Punch is not responsible for the usage or feasibility of installation requirements. This product is not suitable for damp or wet environments

FINISH & SKU NUMBERS

sku:	finish:	size:
UDS-021790	● black	
UDS-051788	● brass	
UDS-351792	● gun metal	
UDS-071787	● steel	

CARE INSTRUCTIONS

Wipe with damp cloth with no loose hairs, avoid using any chemicals. All finishes are prone to aging.