

## 2G DETAIL KIT

---

**ACTION: DETAIL KIT**

---

**RANGE: DETAIL KIT**

---

A dimmer switch detail kit made from solid metal. To be teamed up with our dimmer modules and wall plates to complete your custom electricity product.



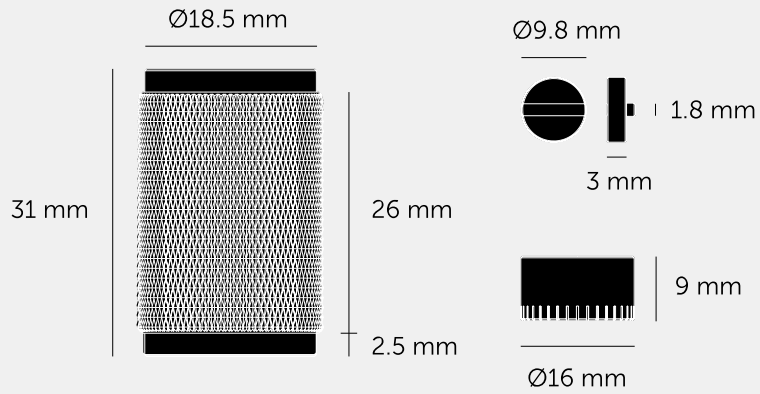

---

**SPECIFICATIONS**

---



---

**INCLUDED**

---



---

**FINISH & SKU NUMBERS**

---

**finish:**

**size:**

---

**PLEASE NOTE**

---

DISCLAIMER: Always consult a trade professional when installing this product. Buster + Punch is not responsible for the usage or feasibility of installation requirements. This product is not suitable for damp or wet environments.

---

**CARE INSTRUCTIONS**

---

Wipe with a dry lint free cloth with no loose hairs, avoid using any chemicals. Please note that finishes may age naturally with time and regular use.