

WR-15 to 1.85mm Female Right Angle Waveguide to Coax Adapters with UG-385/U Flange, 50 - 65GHz

WR15/1.85-UG-K-V

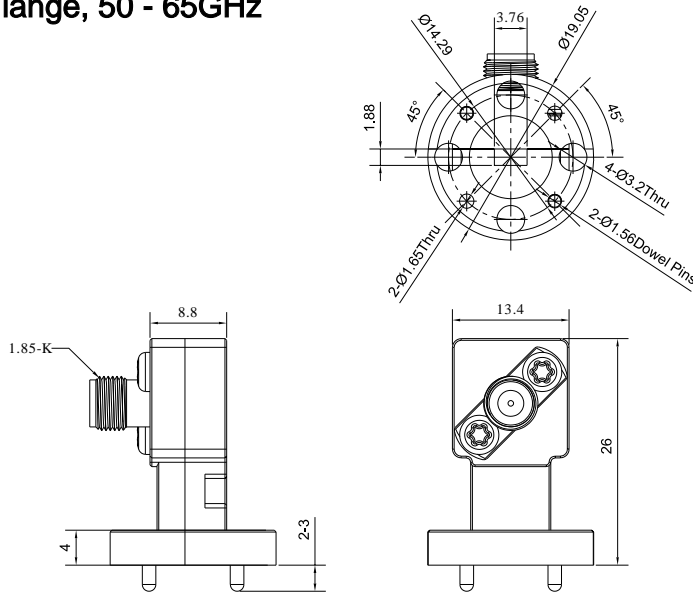

Product Configuration

Body Style	Right Angle
Flange Designation	UG-385/U
Waveguide Size	WR-15
Connector Series	1.85mm
Connector Polarity	Standard
Connector Gender	Female
Connector Impedance (Ohm)	50

Electrical Specifications

VSWR	1.8
Insertion Loss	≤0.8
Frequency Range	50-65GHz

Mechanical Data

Weight (g)	25.25 g
Body Material	Brass

Environmental Specifications

RoHS Compliant	Yes
Operating Temperature Range	-30 °C to +70 °C