

67GHz GSG RF Probe, 150µm Pitch, 1.85mm Female RF Connector, Ultra-Wideband High Frequency Test Probe

P/N: FR8-GPB67-GSG-150

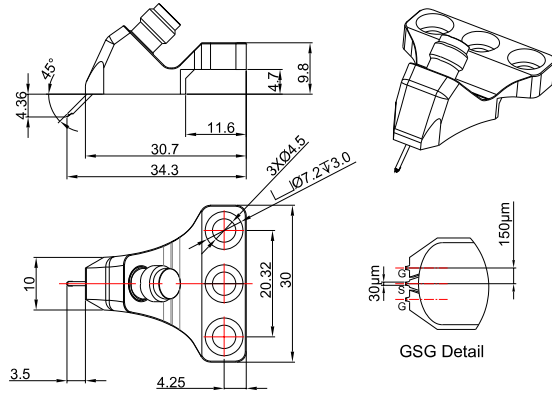

Dimensions are in mm



Product Configuration

Connector 1 Series	1.85mm
Connector 1 Polarity	Standard
Connector 1 Gender	Female
Connector 1 Impedance (Ohm)	50
Probe Configuration	GSG
Pitch	150 µm
Tip Material	Nickel Alloy
Tip Width	30µm
Overtravel	20 – 60 µm
...	...

Electrical Specifications

Frequency	DC - 67GHz
VSWR / Return Loss	15dB
Insertion Loss	0.9dB

Test Report

S11: Minimum return loss for this probe is -17.7dB

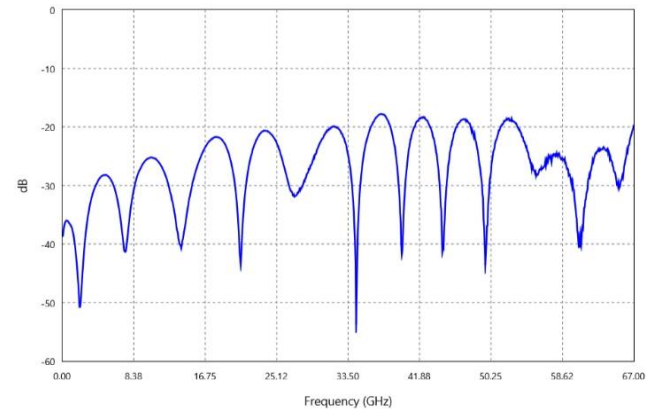

S21: Maximum insertion loss for this probe is -0.66dB

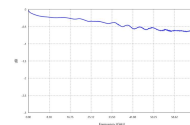

Environmental Specifications

RoHS Compliant	Yes
Operating Temperature Range	-40 °C to +175 °C