

2.92mm Female Connector Field Replaceable with 4 Hole Flange |
Acceptable Pin Diameter 0.3mm | DC - 40GHz

P/N: FR2-2.92-KFD0130

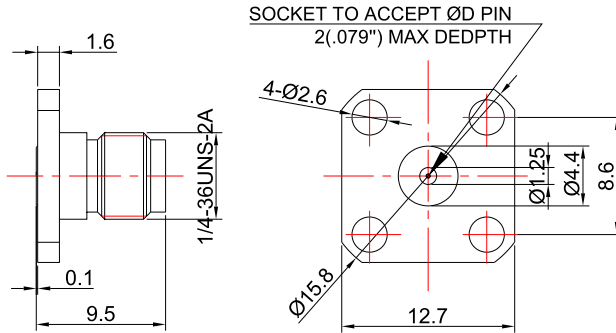

For glass-bead of 0.30mm pin diameter
Dimensions are in mm

Product Configuration

Body Style	Straight
Connector Series	2.92mm
Connector Polarity	Standard
Connector Gender	Female
Termination Type	Field Replaceable Contact
Connector Impedance (Ohm)	50
Mount Method	4 Hole Flange

Electrical Specifications

Frequency	DC - 40GHz
VSWR / Return Loss	1.15
Insertion Loss	≤ 0.1 x Sqrt.(f_GHz)

Mechanical Data

Min. Mating Cycles	≥500
Weight	2.7 g
Body Material	Stainless Steel
Body Plating	Passivated

Environmental Specifications

RoHS Compliant	Yes
Operating Temperature Range	-55 °C to +165 °C
MIL/STD	N/A