

2.92mm Female to 1.85mm Female Adapter, DC - 40GHz

FR1-2.92/1.85-KKS

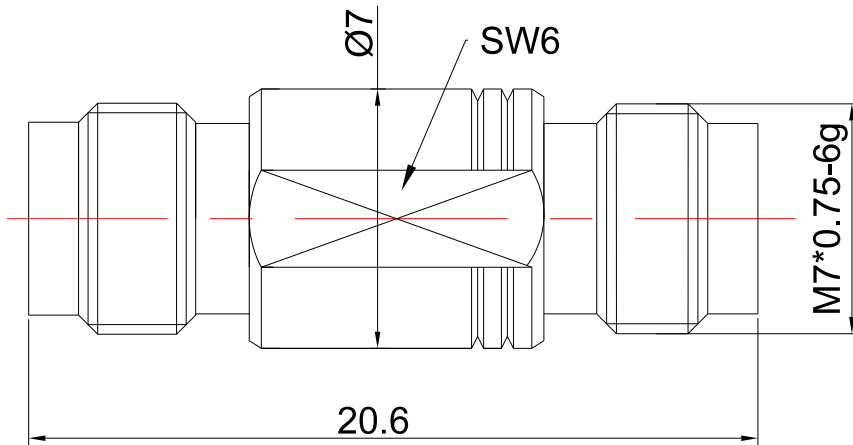

Dimensions are in mm

Product Configuration

Connector 1 Series	2.92mm
Connector 1 Polarity	Standard
Connector 1 Gender	Female
Connector 1 Impedance (Ohm)	50
Connector 1 Mount Method	None
Connector 2 Series	1.85mm
Connector 2 Polarity	Standard
Connector 2 Gender	Female
Connector 2 Impedance (Ohm)	50
Connector 2 Mount Method	None
Body Style	Straight

Mechanical Data

Connector 1 Body Material	Stainless Steel
Connector 1 Body Plating	Passivated
Connector 2 Body Material	Stainless Steel
Connector 2 Body Plating	Passivated
Mating Cycles, Min	≥500
Weight	3.5 g

Electrical Specifications

Frequency	DC-40GHz
VSWR	1.2
Insertion Loss	≤0.05 xSq.(f_GHz)

Environmental Specifications

RoHS Compliant	Yes
Operating Temperature Range	-55 °C to +165 °C
MIL/STD	N/A